



FEATURES

- **Tinted, Bright Black Matrix Picture Tube**
- **181 Channel Selection-** All VHF/UHF channels plus up to 125 cable channels.
- **PLL Frequency Synthesized Tuning-** The latest PLL frequency synthesized electronic tuning system provides free and easy channel selection, and lets you tune directly to any channel using the channel number buttons (0-9 and +100-key) on the remote control.
- **On-Screen Function Display.**
- **Full-Function Remote Control**
- **Sleep Timer**
- **Closed Caption Decoder-** You may view specially labeled (cc) TV programs, movies, news, prerecorded tapes, etc. with either a dialogue caption or text display added to the program.
- **Auto Shut Off Function-** If there is no air signal input from the antenna terminal and no operation for 15 minutes, the TV will turn itself off automatically.
- **V-CHIP-** Enables parents to prevent their children from watching inappropriate material on TV.

PRECAUTION

- Place your TV in a room with adequate ventilation.
- Keep your TV set away from sources of direct heat, such as heat registers or direct sunlight.
- Do not place your TV on soft surfaces, such as rugs or blankets.
- Leave enough room for air to circulate around the bottom, top and back of the set.

The serial number of this product may be found on the back of the TV. No others have the same serial number as yours. You should record the number and other vital information here and retain this book as a permanent record of your purchase to aid identification in case of theft.

Date of Purchase		Dealer Phone No.	
Dealer Purchase from		Model No.	
Dealer Address		Serial No.	

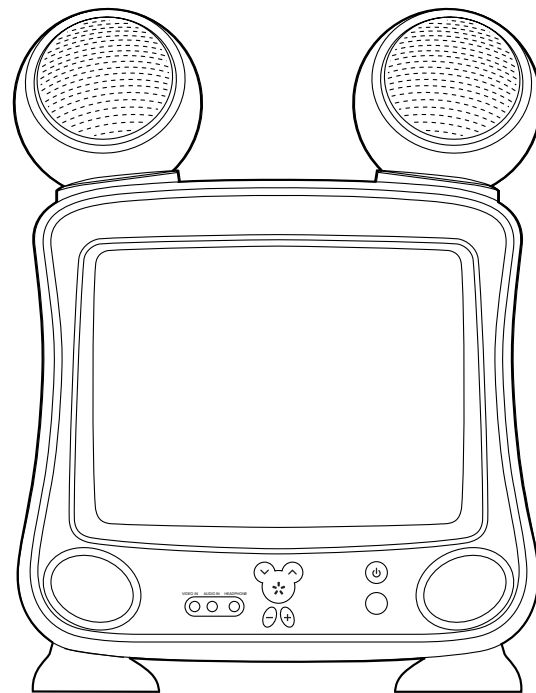
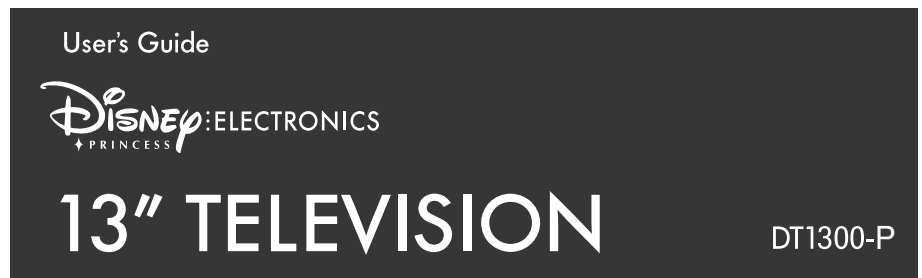

PLEASE READ BEFORE USING THIS EQUIPMENT.
 If you need additional assistance for set-up for operating after reading user's guide, please visit our website, www.memorexelectronics.com or call TOLL FREE: 1-877-DISNYCE(1-877-347-6923).

This Owner's Manual is made of recycled paper.

0EMN02171

Printed in Malaysia
 L6311UM *****

ANTENNA/CABLE CONNECTIONS

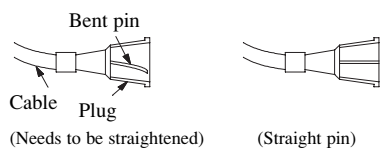

Before plugging the UHF/VHF Rod Antenna (Not supplied) into the ANT(enna). IN jack, check that the pin is not bent. If it is bent, straighten the pin as illustrated, then plug the pin into the ANT(enna). IN jack.

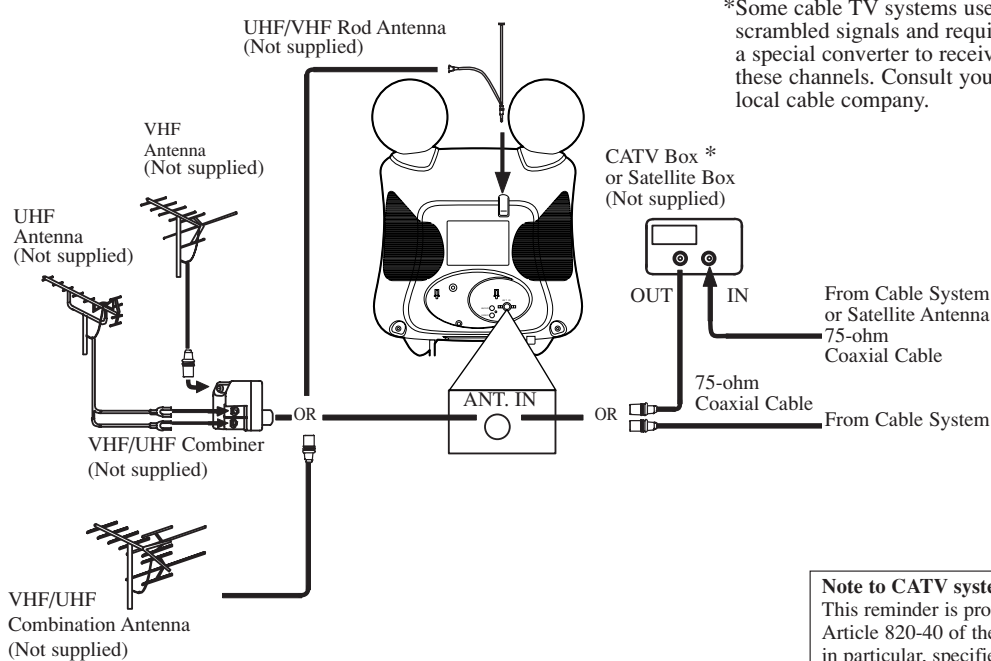

*Some cable TV systems use scrambled signals and require a special converter to receive these channels. Consult your local cable company.

FCC WARNING- This equipment may generate or use radio frequency energy. Changes or modifications to this equipment may cause harmful interference unless the modifications are expressly approved in the instruction manual. The user could lose the authority to operate this equipment if an unauthorized change or modification is made.

CAUTION: TO PREVENT ELECTRIC SHOCK, MATCH WIDE BLADE OF PLUG TO WIDE SLOT, FULLY INSERT.

ATTENTION:
 POUR ÉVITER LES CHOC ÉLECTRIQUES, INTRODUIRE LA LAME LA PLUS LARGE DE LA FICHE DANS LA BORNE CORRESPONDANTE DE LA PRISE ET POUSSER JUSQU'AU FOND.

Note to CATV system installer:
 This reminder is provided to call the CATV system installer's attention to Article 820-40 of the NEC that provides guidelines for proper grounding and, in particular, specifies that the cable ground shall be connected to the grounding system of the building as close to the point of cable entry as practical.

CLOSED CAPTION

This TV can receive C1 and C2 of Caption and Text.

Caption Mode

- (1) Characters can be displayed on the TV screen when the received broadcast signal contains the Caption Signals.
 - (2) **Paint-on mode:** Displays input characters on the screen immediately.
Pop-on mode: Once characters are stored in memory, it is displayed all at once.
Roll-up mode: Displays the characters continuously by scrolling (max. 4 lines)
- Note:** If the CAPTION C1 or C2 is selected but the caption signal is not included, characters will not be displayed.

Text Mode

- (1) Displays the text on the screen by scrolling (max. 7 lines)
- (2) If the received broadcast signal does not contain the caption or text signal, no change will occur.

Notes:

- (1) When your TV receives a special effects playback signal (i.e., Search, Slow, Still) from a VCR's video output channel (CH3 or CH4), your TV may not display the correct caption or text.
- (2) Captions and texts may not match the TV voice exactly.
- (3) Interference may cause the closed caption system to not function properly.
- (4) The caption or text characters will not be displayed while the menu display or function's display is shown.
- (5) **If you see this screen :**



If your TV displays a black box on the screen, this means that your TV is set to TEXT mode. To clear screen, select CAPTION C1, C2 or CAPTION [OFF].

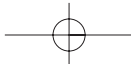

WARNING:
TO REDUCE THE RISK OF FIRE OR ELECTRIC SHOCK, DO NOT EXPOSE THIS APPLIANCE TO RAIN OR MOISTURE.

CAUTION
RISK OF ELECTRIC SHOCK
DO NOT OPEN

CAUTION: TO REDUCE THE RISK OF ELECTRIC SHOCK, DO NOT REMOVE COVER (OR BACK) NO USER SERVICEABLE PARTS INSIDE. REFER SERVICING TO QUALIFIED SERVICE PERSONNEL.

The important note is located on the rear of the cabinet.

THIS SYMBOL INDICATES THAT DANGEROUS VOLTAGE CONSTITUTING A RISK OF ELECTRIC SHOCK IS PRESENT WITHIN THIS UNIT.

THIS SYMBOL INDICATES THAT THERE ARE IMPORTANT OPERATING AND MAINTENANCE INSTRUCTIONS IN THE LITERATURE ACCOMPANYING THE APPLIANCE.

IMPORTANT SAFEGUARDS

- Read instructions-All the safety and operating instructions should be read before the appliance is operated.
- Retain Instructions-The safety and operating instructions should be retained for future reference.
- Heed Warnings-All warnings on the appliance and in the operating instructions should be adhered to.
- Follow Instructions-All operating and use instructions should be followed.
- Cleaning-Unplug TV from the wall outlet before cleaning. Do not use liquid cleaners or aerosol cleaners. Use a damp cloth for cleaning.
EXCEPTION: A product that is meant for uninterrupted service and, that for some specific reason, such as the possibility of the loss of an authorization code for a CATV converter, is not intended to be unplugged by the user for cleaning or any other purpose, may exclude the reference to unplugging the appliance in the cleaning description otherwise required in item 5.
- Attachments-Do not use attachments not recommended by the TV manufacturer as they may cause hazards.
- Water and Moisture-Do not use this TV near water, for example, near a bath tub, wash bowl, kitchen sink, or laundry tub, in a wet basement, or near a swimming pool, and the like.
- Accessories-Do not place this TV on an unstable cart, stand, tripod, bracket, or table. The TV may fall, causing serious injury to someone, and serious damage to the appliance. Use only with a cart, stand, tripod, bracket, or table recommended by the manufacturer, or sold with the TV.
Any mounting of the appliance should follow the manufacturer's instructions and should use a mounting accessory recommended by the manufacturer. An appliance and cart combination should be moved with care. Quick stops, excessive force, and uneven surfaces may cause the appliance and cart combination to overturn.



AMEUBLES- Cet appareil ne doit être placé que sur un meuble (avec ou sans roulettes) recommandé par le fabricant. Si vous l'installez sur un meuble à roulettes, déplacez les deux ensembles avec précaution. Un arrêt brusque, l'utilisation d'une force excessive et des surfaces irrégulières risquent de déstabiliser l'ensemble et de le renverser.



- Ventilation-Slots and openings in the cabinet and the back or bottom are provided for ventilation and to ensure reliable operation of the TV and to protect it from overheating, these openings must not be blocked or covered. The openings should never be blocked by placing the TV on a bed, sofa, rug, or other similar surface. This TV should never be placed near or over a radiator or heat register. This TV should not be placed in a built-in installation such as a bookcase or rack unless proper ventilation is provided or the manufacturer's instructions have been adhered to.
- Power Sources-This TV should be operated only from the type of power source indicated on the marking label. If you are not sure of the type of power supply to your home, consult your appliance dealer or local power company. For TVs intended to operate from battery power, or other sources, refer to the operating instructions.
- Grounding or Polarization-This TV is equipped with a polarized alternating-current line plug (a plug having one blade wider than the other). This plug will fit into the power outlet only one way. This is a safety feature. If you are unable to insert the plug fully into the outlet, try reversing the plug. If the plug should still fail to fit, contact your electrician to replace your obsolete outlet. Do not defeat the safety purpose of the polarized plug.
- Power-Cord Protection-Power-supply cords should be routed so that they are not likely to be walked on or

FIGURE A
EXAMPLE OF ANTENNA GROUNDING AS PER NATIONAL ELECTRICAL CODE

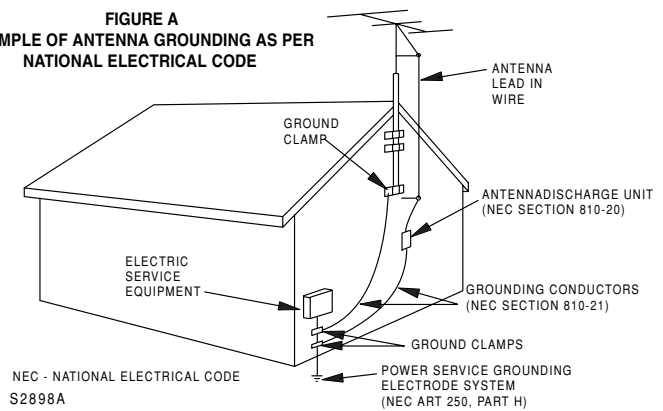

- pinched by items placed upon or against them, paying particular attention to cords at plugs, convenience receptacles, and the point where they exit from the appliance.
- Outdoor Antenna grounding-If an outside antenna or cable system is connected to the TV, be sure the antenna or cable system is grounded so as to provide some protection against voltage surges and built-up static charges. Article 810 of the National Electrical Code, ANSI/NFPA No. 70, provides information with respect to proper grounding of the mast and supporting structure, grounding of the lead-in wire to an antenna discharge unit, size of grounding conductors, location of antenna-discharge unit, connection to grounding electrodes, and requirements for the grounding electrode. (Fig. A)
- Lightning-For added protection for this TV receiver during a lightning storm, or when it is left unattended and unused for long periods of time, unplug it from the wall outlet and disconnect the antenna or cable system. This will prevent damage to the TV due to lightning and power-line surges.
- Power Lines-An outside antenna system should not be located in the vicinity of overhead power lines or other electric light of power circuits, or where it can fall into such power lines or circuits. When installing an outside antenna system, extreme care should be taken to keep from touching such power lines or circuits as contact with them might be fatal.
- Overloading-Do not overload wall outlets and extension cords as this can result in a risk of fire or electric shock.
- Object and Liquid Entry-Never push objects of any kind into this TV through openings as they may touch dangerous voltage points or short out parts that could result in a fire or electric shock. Never spill liquid of any kind on the TV.

18. Servicing-Do not attempt to service this TV yourself as opening or removing covers may expose you to dangerous voltage or other hazards. Refer all servicing to qualified service personnel.
19. Damage Requiring Service-Unplug this TV from the wall outlet and refer servicing to qualified service personnel under the following conditions:
 - When the power supply cord or plug is damaged or frayed.
 - If liquid has been spilled, or objects have fallen into the TV.
 - If the TV has been exposed to rain or water.
 - If the TV does not operate normally by following the operating instructions. Adjust only those controls that are covered by the operating instructions, as improper adjustment of other controls may result in damage and will often require extensive work by a qualified technician to restore the TV to its normal operation.
 - If the TV has been dropped or damaged in any way.
 - When the TV exhibits a distinct change in performance-this indicates a need for service.
20. Replacement Parts-When replacement parts are required, be sure the service technician uses replacement parts specified by the manufacturer that have the same characteristics as the original part. Unauthorized substitutions may result in fire, electric shock, injury to persons or other hazards.
21. Safety Check-Upon completion of any service or repairs to this TV, ask the service technician to perform routine safety checks to determine that the TV is in proper operating condition.
22. Heat-This TV product should be situated away from heat sources such as radiators, heat registers, stoves, or other products (including amplifiers) that produce heat.

OPERATING CONTROLS AND FUNCTIONS

- FRONT PANEL -

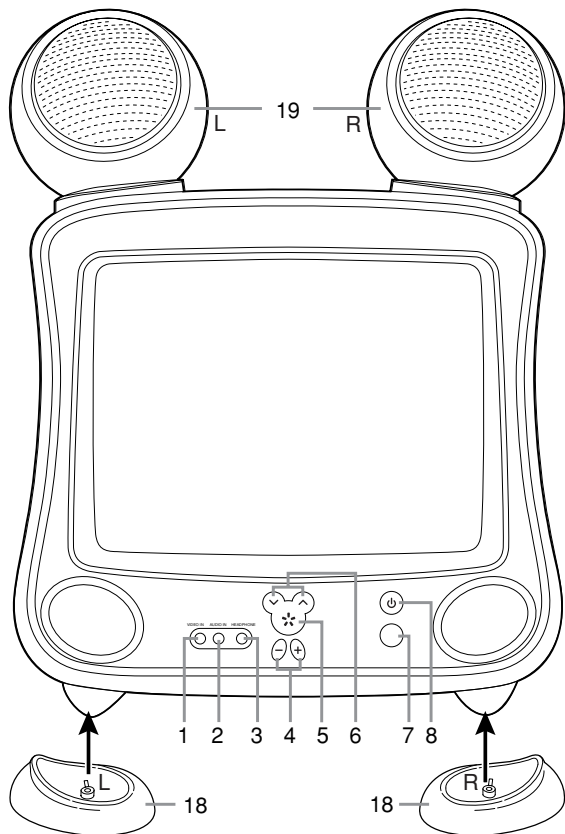

- REMOTE CONTROL -

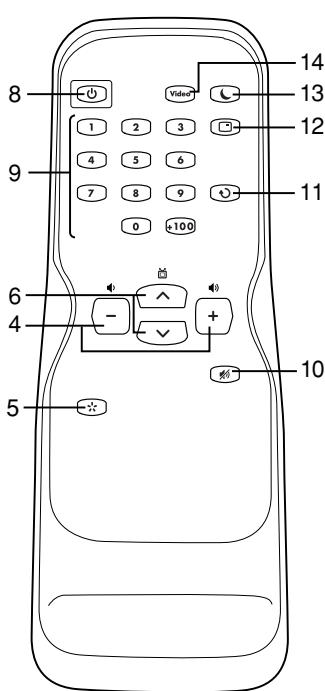

- VIDEO (in) jack**- Connect to the video output jack of a video camera or VCR.
- AUDIO (in) jack**- Connect to the audio output jack of a video camera or VCR.
NOTE: If Video and Audio input are both connected in the front and rear, only the front input will function.
- HEADPHONE jack**- To connect headphone (not supplied) for personal listening.
- / + (VOLUME)**- Press to control the volume level. Press to determine a setting mode from the menu on the TV screen. (only + (Volume))

- Press to select or adjust from a particular menu. (for example: Language Selection, Channel Presetting, Closed Caption Selection, Picture Adjustment, V-CHIP Set Up)
- ☆ (MENU)**- Press to display the menu on the TV screen.
- ∨ / ∧ (CHANNEL)**- Press to select memorized channel.
NOTE: You MUST PRESET channels BEFORE using ∨ / ∧ (CHANNEL). (See CHANNEL PRESETTING)
Press to select a setting mode from the menu on the TV screen.
Press to select item you want to adjust in the picture control mode.
- Infrared Sensor Window**- Receives the infrared control signals from the remote control unit.
- ⏻ (POWER)**- Press to turn the TV ON and OFF.
- CHANNEL NUMBER buttons**- Press two digits to directly access the desired channel. Remember to press a "0" before a single digit channel.
+100 button- Press to select cable channels which are equal or greater than number 100.
- ⏸ (MUTE)**- Press ⏸ (MUTE) to turn off the sound portion of the TV program. Press ⏸ (MUTE) again or press - or + (VOLUME) to restore sound.
- ⏪ (CHANNEL RETURN)**- Press this button to go back to the previously viewed channel. For example, pressing ⏪ (CHANNEL RETURN) once will change channel display from CH 3 (present channel) to CH 10 (previously viewed channel), and pressing it second time will return from CH 10 to CH 3.
- ⏴ (DISPLAY)**- Press to display the channel number on the screen. If you press it again, the channel number will disappear.
- ⏴ (SLEEP)**- Press ⏴ (SLEEP) to display the sleep timer and start the function. The shut off time can be determined by the number of times you press the button. (0, 10, 20, 30, ., 90, 0 minutes)

14. **Video (VIDEO)**- Press to set the VIDEO mode and external input mode at the same time. Press Video (VIDEO) again to exit the mode.
15. **ANT(enna). IN jack**- Connect to an antenna, cable system, or satellite system.
16. **AC cord**- Connect to a standard AC outlet (120V/60Hz).
NOTE: Remove the AC cord from the hook to avoid breaking a wire before you connect to a standard AC outlet.
17. **Screw hole**- Fix the supplied band and screw to stabilize if you place the TV on the Disney DVD player(DVD2000).
18. **TV Shoes (Accessories)**- Put on the TV if desired.
Note: Be sure to determine which shoe is left (L) and which is right (R) as indicated by the letter shown on the shoes. To install, make sure the shape on the shoe matches the hole of the foot, then set each front foot of the TV into the proper shoe.
19. **Removable Speakers (Accessories)**- Install two additional speakers on the TV, if desired. When installed, the original speakers do not have any output sound.
To install, be sure to determine which speaker is left (L) and which is right (R) as indicated by the letter shown on the bottom of the speaker. Insert the tab on the front end of the speaker (hold the speaker at an angle as shown in the diagram) into the small hole on the top of the TV. Lower the other half onto the TV, inserting the plug on the bottom of the speaker into the connector on the TV. Align the holes so that the screws go into the holes. Tighten the screws firmly using a coin or screwdriver.

- REAR PANEL -

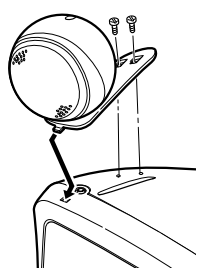
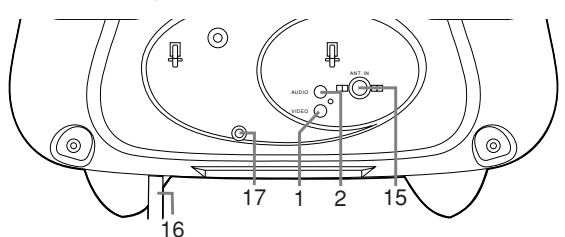



PREPARATION FOR USE

INSTALLING THE BATTERIES

- Slide the battery compartment off the remote unit.
- Insert 2 "AA" penlight batteries into battery compartment in the direction as indicated by the polarity (+ / -) markings. Batteries installed with incorrect polarity may damage the remote unit.
- Replace the cover.

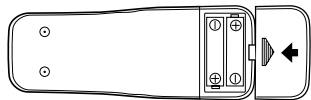

SETTING THE TV ON THE DISNEY DVD PLAYER

If you have a Disney DVD player (DVD2000), the TV can be placed on top of it.

- Make sure that the DVD shoes are fitted.
- Make sure that the TV shoes are removed, and rear feet fit the slots on the DVD player.
- Fix the DVD player and the TV together using supplied band and screw. See the diagram.

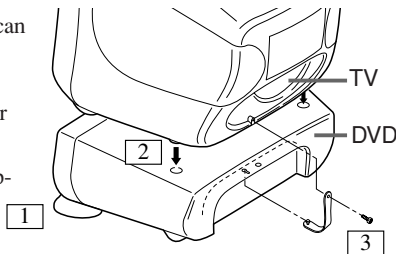

Refer to the Owner's Manuals of Disney DVD player (DVD2000).

LANGUAGE SELECTION

If you want to change the language of the on-screen menu, follow the procedure below.

- Connect the power cord to a standard AC outlet.
- Press **⏻** (POWER) to turn on the TV.
- Press **⚙** (MENU) so that the menu display appears on the TV screen.
- Press **⏴** or **⏵** (Channel) to select "(ENG)/ESP/FRA". Selected item is shown in different color.
- Select "ENG" (English) or "ESP" (Spanish) or "FRA" (French) by using the **-** or **+** (Volume).
- Press **⚙** (MENU) button to exit the menu.

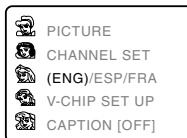
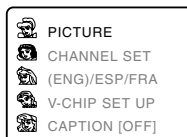

Note: No pictures or sound will come from the TV or external input during menu selection.

CHANNEL PRESETTING

Note: You MUST PRESET channels BEFORE using **⏴** or **⏵** (Channel). To preset a channel or to change a preset channel, follow the procedure below.

- Press **⏻** (POWER) to turn on the TV.
- Press **⚙** (MENU) so that the menu display appears on the TV screen.
- Press **⏴** or **⏵** (Channel) to select "CHANNEL SET". Then, press **+** (Volume).
- Press **⏴** or **⏵** (Channel) to point to "AUTO MEMO". Then, press **+** (Volume).

The tuner scans and memorizes all active channels in your area.

- The TV distinguishes between standard TV channels and cable channels.
- When AUTO MEMO action is completed, the lowest memorized channel reappears on the screen.
- When you press **⏴** or **⏵** (Channel) after selecting AUTO MEMO, the tuner will stop at the memorized channels only.
- The TV may recognize TV channels to be CATV channels depending on the receiving conditions. In this case, try the AUTO MEMO action again when the receiving conditions have improved.

[ADD/DELETE FUNCTION]

- Press the **⚙** (MENU) so that the menu display appears on the TV screen.
- Press **⏴** or **⏵** (Channel) to point to "CHANNEL SET". Then, press **+** (Volume).
- Press **+** (Volume) so that "ADD/DELETE" is selected.
- Use **⏴** or **⏵** (Channel) to select the channel you wish to put into memory or to erase from memory.
 - Note:** The display will return to the normal screen in about 10 seconds. Perform "ADD/DELETE" function while this display appears on the screen.
 - Press **-** or **+** (Volume) to light up the channel number in LIGHT RED if you wish to add the channel into memory.
 - Press **-** or **+** (Volume) to light up the channel number in LIGHT BLUE if you wish to erase the channel from memory.
- Press **⚙** (MENU) to exit the menu.

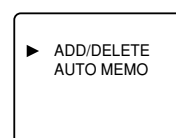
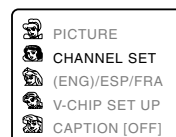
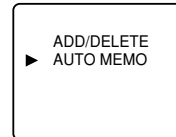
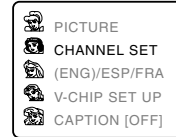
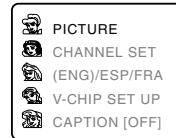

RESUME FUNCTION

If the power fails or is disconnected while the TV is powered on, the TV will turn on automatically when the power resumes.

OPERATIONS

WATCHING A TV PROGRAM

- Press **⏻** (POWER) to turn on the TV.
- Select the desired channel with **⏴** or **⏵** (Channel).
- Adjust the volume to the desired listening level using **-** or **+** (Volume).
- Adjust picture controls for a natural looking image. (See "PICTURE ADJUSTMENT".)

SETTING THE SLEEP TIMER

The sleep timer function enables you to shut off the power without pressing **⏻** (POWER) after a desired time period.

- Press **⏻** (POWER) to turn on the TV and press **⏴** (SLEEP) on the remote control.

- You may change the sleep time with pressing the **⏴** (SLEEP) on the remote control repeatedly. The timer is set up to 90 minutes, 10 minutes each time **⏴** (SLEEP) is pushed. (The timer display counts up and sleep timer will be displayed on the screen when you press **⏴** (SLEEP) on the remote control.)

Note: When you disconnect the unit from the AC outlet, or if you have a power failure, the sleep time will be lost.

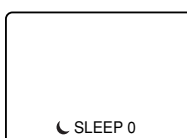

To cancel the sleep timer:
Press **⏴** (SLEEP) repeatedly until " SLEEP 0" is displayed.

CLOSED CAPTION SELECTION

You may view specially labeled (cc) TV programs, movies, news, prerecorded tapes, etc. with either a dialogue caption or text display added to the program.

- Press **⚙** (MENU) so that the menu display appears on the TV screen.
- Press **⏴** or **⏵** (Channel) to select "CAPTION".
- Press **-** or **+** (Volume) to select the mode you wish.
- When done, press **⚙** (MENU) to exit the menu.

⏴ or **⏵**: Press **-** or **+** (Volume).

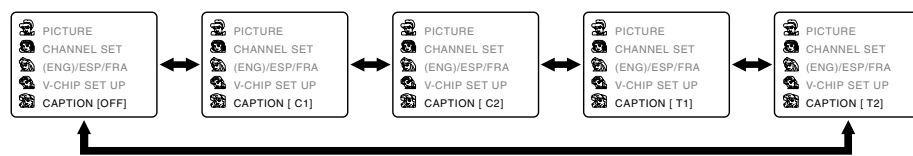

EXTERNAL INPUT MODE

When using an external input signal (VCR, DVD or camcorder), connect the player's audio/video output cables to the AUDIO IN/ VIDEO IN jacks of your TV. Then press **Video** (VIDEO). Press **Video** (VIDEO) again to return to TV mode.

PICTURE ADJUSTMENT

- Press **⚙** (MENU) so that the menu display appears on the TV screen.
- Press **⏴** or **⏵** (Channel) so that "PICTURE" is selected, then press **+** (Volume).
- Select the feature you wish to adjust with **⏴** or **⏵** (Channel) and adjust it with **-** or **+** (Volume).

MOVIE MODE

Set to the most suitable position for the movie.

- [+] : ON
- [-] : OFF

BRIGHTNESS

Adjust until the whitest parts of the picture are as bright as you prefer.

- [+] : increase brightness
- [-] : decrease brightness

CONTRAST

Adjust to increase or decrease contrast.

- [+] : increase contrast
- [-] : decrease contrast

COLOR

Adjust to be brilliant or pale color.

- [+] : be brilliant color
- [-] : be pale color

TINT

Adjust to obtain natural skin tones.

- [+] : increase green tones
- [-] : increase red tones

Notes:

- "+" is achieved by pressing **+** (Volume) and "-" by pressing **-** (Volume).
- In the above steps, the picture adjustment display will disappear from the TV screen after about 10 seconds unless you press any buttons, even though you may not be finished. Press **⚙** (MENU) and **+** (Volume) so that "PICTURE" is selected. Then, press **⏴** or **⏵** (Channel) repeatedly until the display returns to the screen.

⏴ or **⏵**: Press **⏴** or **⏵** (Channel).

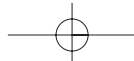
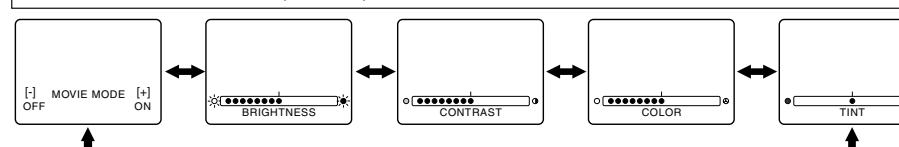

OPERATIONS (Continued)

V-CHIP SET UP

V-CHIP enables parents to prevent their children from watching inappropriate material on TV. V-CHIP reads the ratings for programming (except for news and sports programs, unedited movies on premium cable channels, and Emergency Broadcast System signals), then denies access to programming if the program's rating meets the limitations you select. In this case, "PROTECTED PROGRAM by ..." message appears on the TV screen.

To block ratings, follow the steps below.

- Programming may be rated by the Motion Picture Association of America (MPAA) or according to the Television Parental Guidelines. In order to block any inappropriate programming, set your limits in both places (MPAA RATING and TV RATING).
- You cannot access the menu when the "PROTECTED PROGRAM by ..." message appears. In this case, change to the unblocked channel, then press **☆** (MENU).

MPAA RATING SET UP

1 Press **☆** (MENU) so that the menu display appears on the TV screen.

2 Press **▼** or **▲** (Channel) to select "V-CHIP SET UP". Then, press **+** (Volume).

3 Press **▼** or **▲** (Channel) to point to "MPAA RATING". Then, press **+** (Volume).

4 Press **▼** or **▲** (Channel) to point to your desired item. Then, press **-** or **+** (Volume) to select [BLOCK] or [VIEW].

<Selection>	<Rating Category Explanations>
• G:	General Audience
• PG:	Parental Guidance suggested.
• PG-13:	Unsuitable for children under 13
• R:	Restricted; under 17 requires accompanying parent or adult guardian
• NC-17:	No one under 17 admitted
• X:	Mature audience only

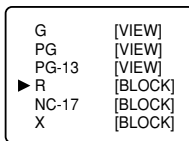
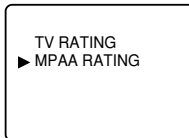
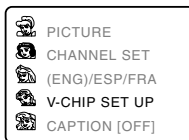

- When you select the rating category and turn it [BLOCK], the higher rating will turn [BLOCK] automatically. Also, the lower rating will turn [VIEW] automatically.
- When you turn "G" to [BLOCK] or [VIEW], the all ratings will turn to [BLOCK] or [VIEW] automatically.
- When you turn "X" to [VIEW], the all ratings will turn to [VIEW] automatically.

5 Press **☆** (MENU) to exit the menu.

TV RATING SET UP

1 Press **☆** (MENU) so that the menu display appears on the TV screen.

2 Press **▼** or **▲** (Channel) to point to "V-CHIP SET UP". Then, press **+** (Volume).

3 Press **▼** or **▲** (Channel) to point to "TV RATING". Then, press **+** (Volume).

4 Press **▼** or **▲** (Channel) to point to your desired item. Then, press **+** (Volume) to select [BLOCK] or [VIEW].

<Selection>	<Rating Category Explanations>
• TV-Y:	Appropriate for all children
• TV-Y7:	Appropriate for children seven and older
• TV-G:	General Audience
• TV-PG:	Parental Guidance suggested.
• TV-14:	Unsuitable for children under 14
• TV-MA:	Mature audience only

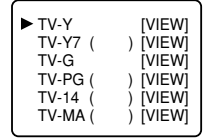
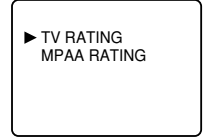
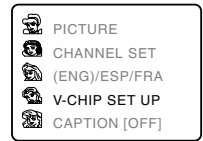

- When you select the rating category and turn it [BLOCK], the higher rating will turn [BLOCK] automatically. Also, the lower rating will turn [VIEW] automatically.
- When you turn "TV-Y" to [BLOCK] or [VIEW], the all ratings will turn to [BLOCK] or [VIEW] automatically.
- When you turn "TV-MA" to [VIEW], the all ratings will turn to [VIEW] automatically.

When you select TV-Y7, TV-PG, TV-14, or TV-MA and you press **+** (Volume) when it is blocked, the sub-ratings will appear on the TV screen.

If you select the rating category (example: TV-PG) and turn it [BLOCK] or [VIEW], the sub-ratings (example: V for Violence) will turn [BLOCK] or [VIEW] automatically. You can set the sub-ratings to [BLOCK] or [VIEW] individually when the rating category is set to [BLOCK]. To set the sub-ratings individually, follow the steps below.

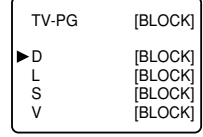
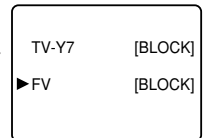

- **When you select [TV-Y7]:**
Press **▼** or **▲** (Channel) to select "FV" (Fantasy Violence). Then, press **-** or **+** (Volume) to select [BLOCK] or [VIEW].
- **When you select [TV-PG], [TV-14] or [TV-MA]:**
Press **▼** or **▲** (Channel) to select "D"(Suggestive Dialog), "L"(Coarse Language), "S"(Sexual Situation), or "V"(Violence). Then, press **-** or **+** (Volume) to select [BLOCK] or [VIEW].
Note: When you select [TV-MA], "D" does not appear on the TV screen.
- The sub-ratings which set to [BLOCK] appears next to the rating category in the TV RATING menu.

5 Press **☆** (MENU) to exit the menu.

TROUBLESHOOTING GUIDE

Sometimes a performance problem can be easily solved by checking seemingly apparent but often overlooked possibilities. Before arranging for service, check these items. It could save your time and money.

QUICK SERVICE CHECK LIST	PROBLEM	POSSIBLE REMEDY													
		Remote Control Doesn't Work	Bars On Screen	Picture Distorted	Picture Rolls Vertically	No Color	Poor Reception on Some Channels	Weak Picture	Lines or Streaks in Picture	Ghosts in picture	Picture Blurred	Sound OK, Picture Poor	Picture OK, Sound Poor	No Picture or Sound	Different color marks on screen
Try a new channel, if OK, then possible station trouble.			X	X	X	X	X	X	X	X	X	X	X	X	X
Is TV plugged in? Power at outlet?	X													X	
Is TV's POWER button on?														X	
Is antenna connected to terminal on the back of the set?					X	X	X	X	X	X	X	X	X	X	
If outside antenna is being used, check for broken wire.		X	X	X	X	X	X	X	X	X	X	X	X	X	
Check for local interference.		X	X	X	X	X	X	X	X	X	X	X	X	X	
Turn off with POWER button and then turn it on after about a minute.														X	
Adjust COLOR control.					X										
Adjust CONTRAST & BRIGHT control.								X			X				
Check batteries in Remote Control.	X														
Move the TV away from the nearby appliances which have Magnetism. Unplug the TV power cord, then plug it in again 30 minutes or so later.														X	

Closed Caption Problem	Possible Remedy
My TV is showing captions that are misspelled.	You are watching a live broadcast and spelling errors made by the closed captioning production company may pass through uncorrected. A prerecorded program will not show any misspelled words because of the normal time available for editing the captions.
My TV will not show the text in its entirety or there is a delay of what is being said.	Captions that are delayed a few seconds behind the actual dialogue are common for live broadcasts. Most captioning production companies can display a dialogue to a maximum of 220 words per minute. If a dialogue exceeds that rate, selective editing is used to insure that the captions remain up-to-date with the current TV screen dialogue.
My captions are scrambled with white boxes on the TV screen.	Interference caused by building, power lines, thunderstorms, etc. may cause scrambled or incomplete captions to appear.
My program guide listed a TV show as being closed captioned but none of the captions were displayed.	Broadcasters may at times use a time compression process to the actual program so that additional advertising time can be given. Since the decoder cannot read the compressed information, captions will be lost.
My prerecorded videotape does not show any captions. The tape box mentions it being closed captioned.	The videotape was either an illegal copying or the tape duplicating company accidentally left out the captioning signals during the copying process.
My TV screen shows a black box on certain channels.	You are in the TEXT mode. Select CAPTION mode or CAPTION [OFF].

MAINTENANCE

CABINET CLEANING

- Wipe the front panel and other exterior surfaces of the TV with a soft cloth immersed in lukewarm water and wrung dry.
- Never use a solvent or alcohol. Do not spray insecticide liquid near the TV. Such chemicals may cause damage and discoloration to the exposed surfaces.

PICTURE TUBE CLEANING

Wipe the picture tube of the TV with a soft cloth. Before cleaning the picture tube, disconnect the power cord.

SUPPLIED ACCESSORIES

- Remote control unit (NE118UD)
- Batteries ("AA" x 2)
- Removable speakers (x 2) and Screws (x 4)
- Band and Screw
- TV shoes (x 2)
- Owner's Manual

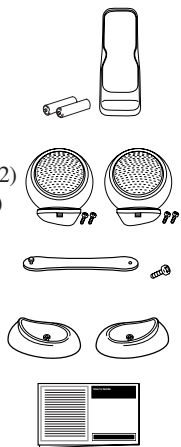

SPECIFICATIONS

GENERAL SPECIFICATIONS

Television system:	NTSC-M TV Standard
Closed Caption System:	\$15.119/FCC
Channel coverage	VHF: 2 ~ 13 UHF: 14 ~ 69 CATV: 2 ~ 13, A ~ W, W+1 ~ W+84, A-5 ~ A-1, 5A
Tuning System	181 channel frequency synthesized tuning system
Channel access:	Direct access keyboard, programmable scan and up/down
Terminals	Antenna input: VHF/UHF/CATV 75 ohm unbalanced (F-type) Video input: RCA connector x 2 Audio input: RCA connector x 2 Speaker output: RCA connector x 2 Headphone: 1/8" monaural (3.5mm)

ELECTRICAL SPECIFICATIONS

Sound output: 1W, 8 ohm in total

OTHER SPECIFICATIONS

Remote control:	Digital encoded infrared light system
Operating temperature:	5°C to 40°C (41°F~104°F)
Power requirements:	AC120V, 60Hz
Power consumption (Maximum):	53W
Picture tube:	13"
Dimensions:	H: 15-7/16"(392mm)
(Without speakers and shoes)	W: 15-7/8"(403mm)
	D: 14-1/2"(368mm)
Weight:	21.4 lbs. (9.7kg)

- Designs and specifications are subject to change without notice and without our legal obligation.
- If there is a discrepancy between languages, the default language will be English.